

LED AREA LIGHT LumCADEN

The LumCADEN is a versatile, modern luminaire engineered to meet a wide range of application needs—from area lighting to floodlighting—through its broad lumen output range and flexible mounting options.

Featuring a contemporary low-profile design, LumCADEN delivers industry-leading performance powered by advanced LED technology, achieving over 160 lumens per watt—among the highest efficacy levels available in the market today.

Combining exceptional performance with outstanding value, LumCADEN is a cost-effective solution for both new construction and retrofit projects, making it an ideal choice for ESCOs, national accounts, and distributor programs.



LumCADEN 85W TO 180W LC1



LumCADEN 200W TO 300W LC2

FEATURES

CONSTRUCTION

- One piece die-cast aluminum body
- Standard 4KV Surge Protection
- 0-10v dimming driver
- 70 CRI

LISTING

- UL and cUL Listed
- IP65 Wet Location Rated
- DLC Listed Premium
- 5-Year Warranty

HOUSING

- Integrated heat sink cooling fins
- Unsurpassed thermal dissipation extending lifetime fixture performance
- Easy access with hinged door

FINISH

- UV stabilized powder coated finish
- Bronze standard

LENS

- High Impact Polycarbonate lens
- Type III, Type IV, Type V optics

OPTIONS

- Alternative 277v -480v driver
- Bi-Level Motion Sensor
- Photocontrol
- 3R, 5R and 7R Pin Receptacles
- House Side Shield
- Trunnion, Knuckle, Wall Mounting



SPECIFICATIONS

Lumen Package (LM):	Up to 43,849 lumens
Wattage Range (W):	85 to 300 watts
Efficacy Range (LPW):	143 to 163 LPW
Product Weight:	10LBS(LC1)/13.2LBS(LC2)
Carton LBS:	1.8LBS(LC1)/1.89LBS(LC2)

Specialized expertise and focus on ESCOs, national accounts and distributor partnerships

Call 866-458-6372 for assistance.

ORDERING GUIDE

Series	Wattage	CCT	Distribution
LC1 LumCADEN ¹ LC2 LumCADEN ²	085 85 watts 120 120 watts 180 180 watts 200 200 watts 300 300 watts	4 4000K 5 5000K	3 Type III 4 Type IV 5 Type V

Voltage	Mounting	Color	Controls-Options
U Universal 120-277v H1 High voltage 347v H2 High voltage 480v	A Arm Mount K Knuckle-Split fitter T Trunnion W Wall Mount	AL Aluminum BK Black BZ Bronze WH White	PC Photo Control OC Occupancy Sensor 3R 3 Pin Receptacle 5R 5 Pin Receptacle 7R 7 Pin Receptacle XS 10kv Surge Protection HS House Side Shield

Foot Notes:
 1 LC1 for 80 to 180 watts only
 2 LC2 for 200 to 300 watts only

OPTIONS



Bi-Level Sensor Control



Wall Mount



Trunnion and Slip Fitter



House Side Shield

Specialized expertise and focus on ESCOs, national accounts and distributor partnerships
 Call 866-458-6372 for assistance.

DISTRIBUTION

LC1 Type III
ISO illuminance diagram(Lux)

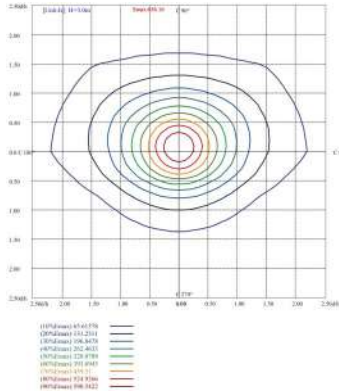

LC1 Type III
Polar Curves

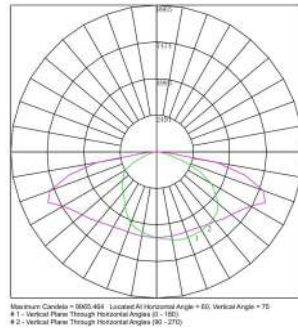

LC2 Type III
ISO illuminance diagram(Lux)

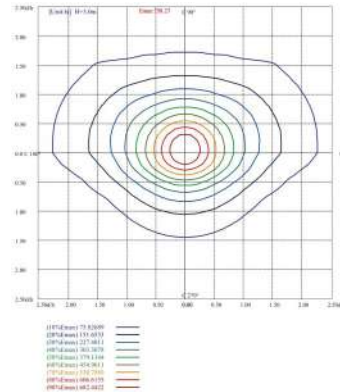

LC2 Type III
Polar Curves

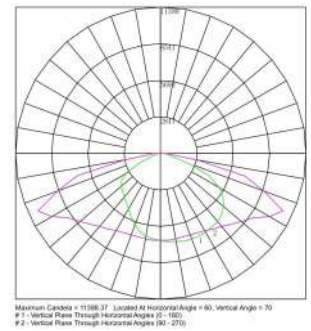

PERFORMANCE DATA

PERFORMANCE DATA			4000K			5000K						
Lumen Package	Distribution	CRI	Delivered Lumens	Efficacy (LPW)	BUG Rating			Delivered Lumens	Efficacy (LPW)	BUG Rating		
					B	U	G			B	U	G
85 watts	3 Type III	70	12939.7	154.6	3	2	3	13663	161	3	2	3
	4 Type IV	70	12423	148	2	2	3	12593	149	2	2	3
	5 Type V	70	13017	156	3	2	2	13350	157	3	2	2
120 watts	3 Type III	70	18027.5	148.4	3	3	3	18341	153	3	3	3
	4 Type IV	70	17929	149	3	3	3	18033	148	3	3	3
	5 Type V	70	18603	155	4	2	2	19728	163	4	2	2
180 watts	3 Type III	70	25135	141.2	3	3	3	25160	144	3	3	3
	4 Type IV	70	25314	145	3	3	3	254878	143	3	3	3
	5 Type V	70	25492	143	4	3	2	25650	147	4	3	2
200 watts	3 Type III	70	29859	150.7	4	3	4	30710	152	4	3	4
	4 Type IV	70	28457	144	3	3	3	29006	144	3	3	3
	5 Type V	70	30129	152	4	3	3	30510	151	4	3	3
300 watts	3 Type III	70	44950	149.4	5	3	5	44971	152	5	3	5
	4 Type IV	70	41507	138	5	3	5	42033	143	5	3	5
	5 Type V	70	43708	148	5	3	3	43849	146	5	3	3

Specialized expertise and focus on ESCOs, national accounts and distributor partnerships
Call 866-458-6372 for assistance.

LUMEN MAINTENANCE TESTING DATA

LUMINAIRE AMBIENT TEMPERATURE FACTOR(LATF)		
Ambient Temp		Lumen Multiplier
(°C)	(°F)	
0°C	32°F	/
10°C	50°F	1.03
20°C	68°F	1.02
30°C	77°F	0.99
40°C	86°F	0.97
50°C	104°F	0.95

ELECTRICAL DATA

Nominal Wattage	Input Voltage	Current Amps
85watts	120	0.7083
	208	0.4087
	240	0.3542
	277	0.3069
	347	0.245
	480	0.1771
120 watts	120	1
	208	0.5769
	240	0.5
	277	0.4332
	347	0.3458
	480	0.25
180 watts	120	1.5
	208	0.8654
	240	0.75
	277	0.6498
	347	0.5187
	480	0.375
200 watts	120	1.6667
	208	0.9615
	240	0.8333
	277	0.722
	347	0.5764
	480	0.4167
300 watts	120	2.5
	208	1.4423
	240	1.25
	277	1.083
	347	0.8646
	480	0.625





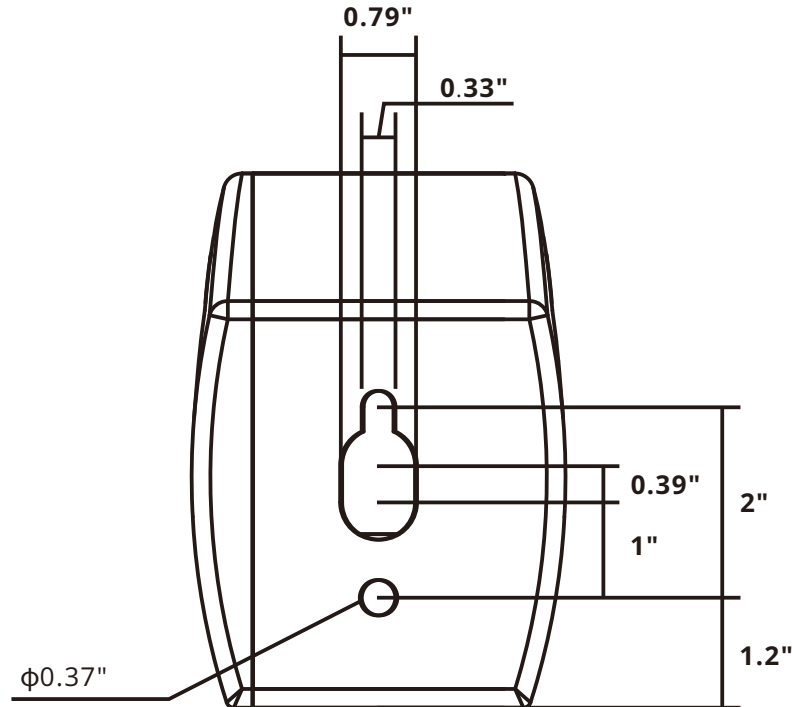

Specialized expertise and focus on ESCOs, national accounts and distributor partnerships
Call 866-458-6372 for assistance.

DRILL PATTERN



EPA VALUES AND WEIGHTS

EPA VALUES

Mounting Types		EPA (Sq. Ft.)
Single		0.51
Double at 90°		1.02
Double at 180°		0.91
Triple at 90°		1.42
Triple at 120°		1.65
Quad at 90°		1.65

EPA Values noted above are measured at zero degrees tilt

WEIGHT

Fixture Size	Weight LBS	Weight KGS
85watts	10	4.54
120 watts	10	4.54
180 watts	10	4.54
200 watts	13.2	5.98
300 watts	13.2	5.98

Specialized expertise and focus on ESCOs, national accounts and distributor partnerships
 Call 866-458-6372 for assistance.

CONTROLS COVERAGE and SETTINGS

MOTION SENSOR INSTRUCTIONS

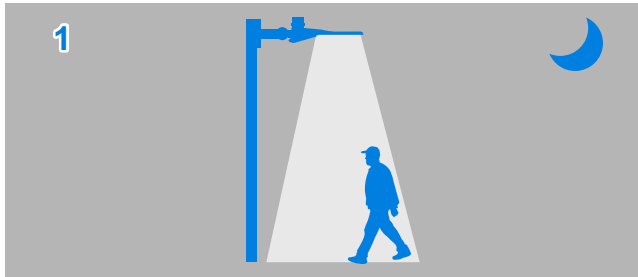

Typically, the sensor ramps lighting On to the selected High mode level when motion is detected and the ambient light level is below the hold off setpoint.

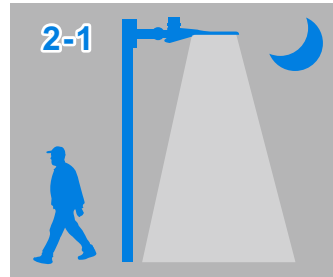

After the sensor stops detecting movement and the time delay elapses, lights fade to the Low mode level. If there is no motion during the subsequent cut off time delay, the lights will turn Off.

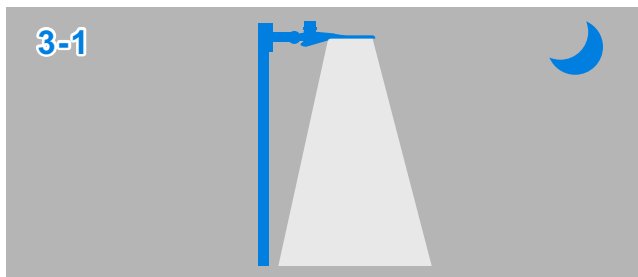
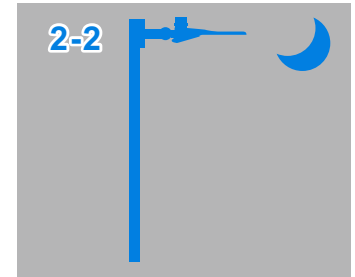

For dusk to dawn control, the integral photocell can switch the lights On and Off based on the ambient light level so that lighting remains on overnight even without motion detection.

SENSOR OPERATIONS

Standard Programming	On Event	Off Event	On Light Level	Dim Light Level	Delay to off
Standard Programming	Customizable with Remote				
On Event	Sensor powers up to 100% when motion is detected and ambient light is below the hold off point.				
Off Event	Sensor begins time delay upon sensor stops detecting movement at which no additional movement detected the lights will be turned off.				
Delayed to Dim	The level of light the Sensor is established to dim the light down to when sensor stops detecting movement.				
Off Event	Sensor begins time delay upon sensor stops detecting movement at which no additional movement detected the lights will be turned off.				
Dusk to Dawn	Integral photocell will switch lights on and Off based on ambient light level				

Specialized expertise and focus on ESCOs, national accounts and distributor partnerships
Call 866-458-6372 for assistance.

DIMENSIONS

LumCADEN 85w to 180w (LC1)

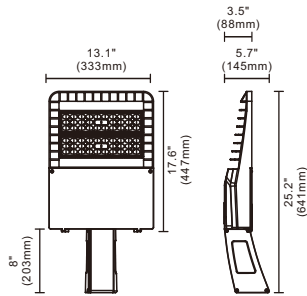

Arm Mount

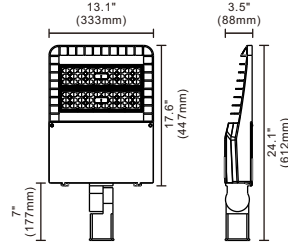

Knuckle Mount

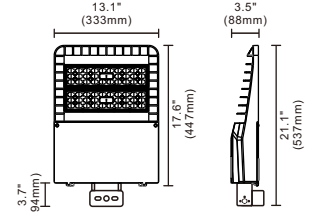

Trunnion Mount

LumCADEN 200w to 300w (LC2)

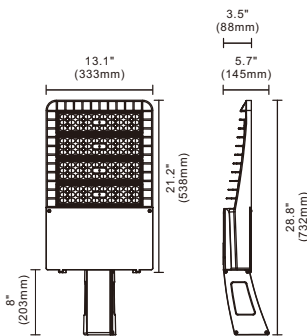

Arm Mount

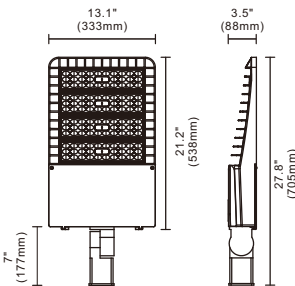

Knuckle Mount

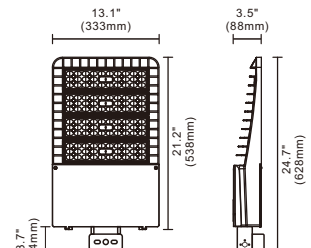

Trunnion Mount

CARTON DIMENSIONS

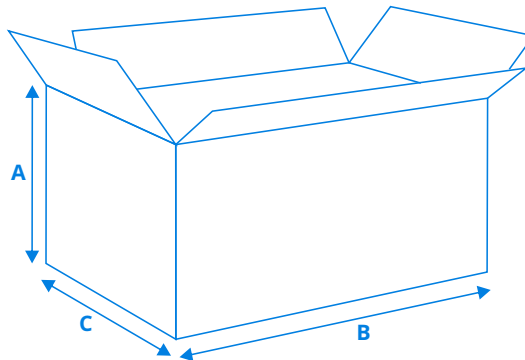

Weights	Master Carton				
	Carton Pack	Master Carton Weight LBS	Height A	Width B	Depth C
(LC1) 85/120/180 watts	1pc/ctn	1.8	5 1/4"	19 5/8"	14 5/8"
(LC2) 200/300 watts	1pc/ctn	1.89	5 1/4"	23 1/4"	14 5/8"

Specialized expertise and focus on ESCOs, national accounts and distributor partnerships
Call 866-458-6372 for assistance.